

Safety Instructions & Operators Manual

COUNTRY CLIPPER

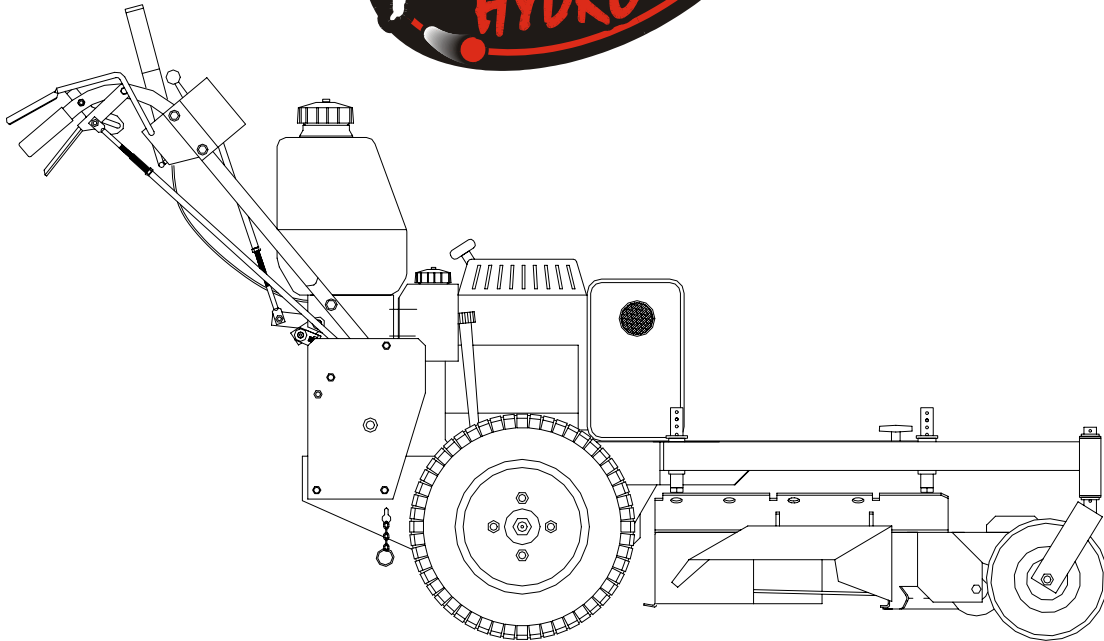

Congratulations for buying a **Country Clipper** product. Your **Country Clipper** Hydrostatic Drive Walk-behind Mower was designed and built to provide long and trouble free service. Keep in mind that it, like any other mechanical device, can be potentially dangerous if used improperly, and hazard control and accident prevention are dependent upon the awareness, concern, prudence, and proper training of personnel involved in the operation, transport, maintenance, and storage of the equipment. Study this manual and pay special attention to the important Safety Precautions on pages 4-6. Following these instructions will help you continue to enjoy the trouble-free performance expected of the **Country Clipper** product.

TABLE OF CONTENTS

***SAFETY*.....4**
 ACCIDENT PATTERNS TO AVOID4
 SAFETY INSTRUCTIONS AND RECOMMENDATIONS4
 SAFETY INTERLOCK SYSTEM.....6
***START UP AND OPERATION*7**
 CHECKLIST BEFORE OPERATION.....7
 CONTROL LOCATIONS7
 OPERATION8
 MOWING RECOMMENDATIONS10
***SPECIFICATIONS*.....11**
***MAINTENANCE*.....12**
 MAINTENANCE SCHEDULE12
 MAINTENANCE INSTRUCTIONS13
***TROUBLE SHOOTING CHECKLIST*17**
***BELT ROUTINGS*.....19**
***WIRING SCHEMATICS*20**
***HYDRAULIC SCHEMATIC*.....21**
***NOTES / SERVICE RECORDS*21**

SAFETY

ACCIDENT PATTERNS TO AVOID

- I. **CONTACT WITH THE ROTATING BLADE** -- This accident usually happens when the operator is clearing the discharge chute of grass, (especially when the grass is wet), or when the operator adjusts the machine without turning it off and waiting for the blades to completely stop.
- II. **PROPELLED OBJECTS** -- Sticks, rocks, wires, and other objects can be propelled out through the discharge chute or from under the mower housing. Bystanders are particularly vulnerable.
- III. **GRASS CATCHER OR GUARD** -- The mower shall not be operated without either the entire grass catcher or guard in place.
- IV. **OVERTURNING** -- This happens when mowers are used on steep slopes, embankments or hills. The operator in these cases can come in contact with the blades or sustain injuries during a fall.
- V. **MOWER RUNNING OVER THE VICTIM** - This usually happens when a mower is driven in reverse. The accident victims are most often young children whom, unseen by the operator of the mower, were in the area being mowed.

AT **COUNTRY CLIPPER**, WE SHARE YOUR DESIRE TO PROTECT YOURSELF, YOUR FAMILY, YOUR FRIENDS AND YOUR NEIGHBORS FROM ACCIDENTAL INJURY. OBSERVING AND ENFORCING THE FOLLOWING GUIDELINES WILL HELP TO INSURE THE SAFETY OF EVERYONE.

PLEASE BE CAREFUL

SAFETY INSTRUCTIONS AND RECOMMENDATIONS

1. **PEOPLE WHO OPERATE, SERVICE, OR ARE OTHERWISE ASSOCIATED** with the **Country Clipper** Hydrostatic Drive Walk-behind Mower should be trained in its proper use and warned of its dangers. Before operating, adjusting, or servicing the **Country Clipper** Hydrostatic Drive Walk-behind Mower they should read and understand this entire manual and the engine owner's manual. If the operator(s) or mechanic(s) can not read English it is the owner's responsibility to explain this material to them. The owner/user can prevent and is responsible for accidents or injuries occurring to themselves, other people or property.
2. **AVOID CONTACT WITH MOVING PARTS.** Keep hands and feet from under mowing deck and away from blades at all times. Turn engine (motor) off if you must unplug the chute.
3. **AVOID HILLS AND SLOPES.** Use extreme caution when mowing across slopes. NEVER mow up and down the face of a slope. Reduce speed and use caution to start, stop and maneuver. To prevent loss of control on a slope avoid sharp turns, sudden changes in direction, and sudden stops and starts.
4. **DISENGAGE POWER TO MOWER BEFORE BACKING UP.** Do not mow in reverse unless ABSOLUTELY necessary and then only after turning around and observing the entire area behind the mower. Go slowly. Most "running over victim" accidents occur in reverse.
5. **BEGINNING OPERATORS SHOULD LEARN HOW TO STEER** the **Country Clipper** Hydrostatic Drive Walk-behind Mower before attempting to mow. Start with slow engine speed and drive without the blades engaged in an open area until comfortable with the machine.
6. **KNOW HOW TO STOP QUICKLY.** Know the location and operation of every control, especially how to brake and how to disengage the mower blades.

7. **DO NOT MOVE SHIFT HANDLE(S) OR TWIN TRACK GROUND SPEED LEVER(S)** from forward position to reverse position rapidly. The speed and/or direction of travel is instantly affected by movement of these controls.
8. **DO NOT ALLOW CHILDREN TO OPERATE MOWER.** Do not allow others who have not had instruction to operate mower.
9. **ALWAYS TURN ENGINE OFF AND REMOVE KEY** before leaving the mower to prevent children and inexperienced operators from starting the engine. Never leave the mower unattended with engine running. Always wait for all moving parts and all sounds to stop before leaving operator's position.
10. **WEAR STURDY, ROUGH-SOLED WORK SHOES AND CLOSE-FITTING SLACKS AND SHIRTS.** Never operate mower in bare feet, sandals or sneakers. Loose fitting clothing, jewelry or long hair can become entangled in moving parts.
11. **NEVER CARRY PASSENGERS.**
12. **KNOW THE AREA YOU ARE TO MOW.** Watch for hidden danger such as rocks, roots, sticks, holes, bumps, and drop-offs, etc. Before mowing, pick up all debris in area to be mowed. Sharp and hard objects can be propelled at a high speed and can act like shrapnel. Walk through tall grass BEFORE MOWING to make sure there are no hidden dangers. Mow higher than desired in tall grass to expose any hidden objects and/or obstacles, clean the area, and then mow to the desired height.
13. **NEVER MOW WHEN OTHER PEOPLE OR PETS ARE IN THE AREA.**
14. **NEVER REFUEL A MOWER INDOORS.** Allow the engine time to cool before refueling. Unseen vapors may be ignited by a spark. Always clean up spilled gasoline. Never run the engine indoors in a garage or any other closed building. Allow engine to cool before storing in any enclosure. The engine exhaust and gasoline fumes are dangerous.
15. **NEVER REMOVE THE FUEL CAP** or add gasoline to a running or hot engine that has not been allowed to cool for several minutes after running. Always make sure the gas cap is in place.
16. **DO NOT SMOKE AROUND THE MOWER** or the gasoline storage container. Gasoline fumes can easily ignite.
17. **DO NOT STEP OR STAND ON THE MOWER HOUSING.**
18. **WATCH OUT FOR TRAFFIC** near roadways and when crossing roads. Slow down when near roadways and sidewalks.
19. **KEEP GASOLINE IN A WELL-VENTILATED AREA** away from your living quarters and in tightly-capped safety cans. Never store mower with gasoline in the tank inside a building where fumes may reach open flame or spark. Use approved container to store gasoline.
20. **DISENGAGE BLADES, STOP ENGINE AND REMOVE IGNITION KEY** before any servicing, including emptying a grass collection system or unclogging the discharge chute. Be sure all moving parts and all sounds have stopped. Let engine cool and disconnect the spark plugs so the engine cannot start by accident. A SLIGHT ROTATION OF THE BLADES COULD START THE ENGINE.
21. **KEEP ALL NUTS, BOLTS, AND SCREWS TIGHT** to be sure equipment is in safe working condition, especially blade mounting bolts. Keep all parts in working order.
22. **VEHICLE SHOULD BE STOPPED AND INSPECTED FOR DAMAGE** after striking a foreign object and the damage should be repaired before restarting and operating the equipment. Stop immediately and check for damage or loose parts if mower should start vibrating.
23. **DISENGAGE BLADES BEFORE DRIVING ACROSS WALKS, DRIVEWAYS** or projecting objects.
24. **KEEP SAFETY DEVICES AND GUARDS IN PLACE.** If any of the safety switches or devices become inoperable, have them repaired immediately.
25. **NEVER OPERATE WITHOUT GRASS DEFLECTOR** or entire grass collection system in place and in proper working order.
26. **DO NOT USE MOWER WHEN GRASS IS WET AND SLIPPERY.** Reduced footing could cause slipping.
27. **WALK, NEVER RUN BEHIND MOWER.** Be sure of your footing at all times.
28. **MOW ONLY DURING DAYLIGHT.**
29. **THIS MACHINE IS NOT MEANT FOR HIGHWAY OR STREET USE.** It is not a

recreational vehicle and it should not be operated as such.

30. **ALWAYS DISENGAGE THE MOWER BLADE CLUTCH** when transporting.
31. **KEEP BODY AND HANDS AWAY FROM PIN HOLES OR LEAKS IN HIGH PRESSURE HYDRAULIC LINES.** Always use paper or cardboard to search for leaks, **NEVER** use hands. Make sure all hydraulic connections are tight and that hydraulic lines are in good condition before starting the engine.
32. **NEVER PERFORM MAINTENANCE ON HYDRAULIC LINES OR FITTINGS WHILE ENGINE IS RUNNING.**
33. **KEEP ALL SAFETY LABELS IN LEGIBLE CONDITION.** Remove grease, dirt, grass, etc. that may cover safety labels. Replace any safety label that is missing or damaged.
34. **WEAR PERSONAL PROTECTIVE EQUIPMENT.** Eye, ear, feet and head protection is recommended.
35. **ONLY USE COUNTRY CLIPPER APPROVED ACCESSORIES.**
36. **NEVER RAISE DECK WITH BLADES RUNNING.**
37. **DO NOT CHANGE THE ENGINE GOVERNOR SETTING** or over speed the engine.
38. **BEWARE OF MOWER DISCHARGE DIRECTION** and do not point it at anyone.
39. **DO NOT OPERATE THE MOWER UNDER THE INFLUENCE OF ALCOHOL OR DRUGS.**
40. **USE CARE WHEN LOADING OR UNLOADING MACHINE INTO A TRAILER OR TRUCK.**
41. **USE CARE WHEN APPROACHING BLIND CORNERS,** shrubs, trees, or other objects that may obscure vision.
42. **CLEAN ALL GRASS AND DEBRIS FROM MACHINE TO PREVENT FIRES.** Remove spilled oil or gasoline.
43. **CAREFULLY RELEASE PRESSURE FROM COMPONENTS WITH STORED ENERGY.**

44. **USE CARE WHEN REPLACING BLADES.** Wrap the blade(s) or wear gloves, and use caution when servicing them. Only replace blade(s). Never straighten or weld blade(s).
45. **KEEP HANDS AND FEET AWAY FROM MOVING PARTS.** If possible do not make adjustments with the engine running.
46. **USE JACKSTANDS TO SUPPORT COMPONENTS** when required.

SAFETY INTERLOCK SYSTEM

Your **Country Clipper** Hydrostatic Drive Walk-behind Mower is equipped with switches interlocked for your safety.

1. The PTO must be disengaged before the engine will start.
2. The Twin Track Ground Speed Levers must be in Neutral before the engine will start.
3. The Key switch Must be "ON" before the engine will start.
4. The engine will stop if the Operator releases the Operator Presence Bail when the Twin Track Ground Speed Levers are out of neutral.
5. The engine will stop if the Operator releases the Operator Presence Bail when the PTO is engaged.

DO NOT OPERATE THE COUNTRY CLIPPER HYDROSTATIC DRIVE WALK-BEHIND MOWER IF SAFETY SWITCHES AND GUARDS ARE NOT OPERATING PROPERLY

START UP AND OPERATION

CHECKLIST BEFORE OPERATION

1. Make sure fuel tank is full. Use regular unleaded gasoline (see engine owner's manual for more details)



DANGER



HANDLE GASOLINE WITH CARE – IT IS HIGHLY FLAMMABLE. DO NOT SMOKE. ENGINE SHOULD BE OFF AND COOL. USE APPROVED GASOLINE CONTAINER. NEVER FILL FUEL TANK INDOORS. WIPE UP ANY SPILLS. REPLACE CAP TIGHTLY.

Make sure dirt and foreign matter is kept out of fuel tank. Use clean funnel and gas can.

Do not mix oil with fuel.

Do not use white, high test or premium gasoline. Do not use de-icers, carburetor cleaners, or other such additives.

2. Check the crankcase oil level. Make sure the engine is off. The mower should be parked on a level area. Do not overfill. (See your engine manual for more detailed instruction.)
3. Check the hydrostatic transmission oil level. (See "Maintenance" section of this manual.)
4. Inspect V-belts.
5. Check tire pressure. Set all tires to 16 psi
6. Make sure underside of mower deck is free of grass.
7. Make sure mower blades are sharp and secured tightly.
8. Clean the air intake screen on the engine if necessary.
9. Perform any other maintenance as it becomes necessary. (See the "Maintenance" section of this manual.)

IMPORTANT: Before cutting grass, clutch must be broken-in as follows: With engine at full RPM engage deck until blades come to full speed and then disengage until blades come to a complete stop. Repeat 10 times to seat clutch properly.

CONTROL LOCATIONS

1. OPERATOR PRESENCE BAIL

Located above the handle bar/grip assemblies. When held down against the handle grips, the Operator Presence Bail senses that the operator is in the normal operator's position. If the operator releases the Operator Presence Bail while either the Twin Track Ground Speed Levers are out of neutral or the PTO switch is engaged the engine will stop running.

2. TWIN TRACK GROUND SPEED LEVER(S)

Located in the center of the Control Console. The right hand and/or left hand Twin Track Ground Speed Lever sets the maximum forward ground speed for the right hand and/or left hand Hydrostatic Transmission.

3. PTO SWITCH

Located on the upper left hand corner of the control console. When pulled "UP" into the engage position, starts the electric clutch for the mower blades.

4. FUEL SHUT-OFF VALVE

Located on the bottom of the fuel tank. Opening the Fuel Shut-off Valve turns fuel supply to engine on.

5. SHIFT HANDLE(S)

Located just below each handle grip. Squeezing the left hand and/or right hand Shift Handle causes the left hand and/or right hand Hydrostatic Transmission to slow down, stop or travel into reverse, depending on how far the respective Shift Handle is squeezed.

The Shift Handles will have no effect on forward travel of the machine if the Twin Track Ground Speed Lever(s) are in neutral or if the Neutral Latches are in the "lock" position.

Squeezing the Shift Handles beyond neutral (closer to the handle grips) will shift the hydrostatic transmissions into the reverse direction.

6. NEUTRAL LATCHES

Located above the Shift Handles and on the inside of the handle bars. While squeezing the Shift Handles and holding the Hydrostatic Transmissions in neutral, rotation of the top "thumb grip" portion of Neutral Latches towards the rear of the machine will lock the Shift Handles into neutral. To release Neutral Latches squeeze the Shift Handles until they "fall" off of the locked position.

7. KEY SWITCH

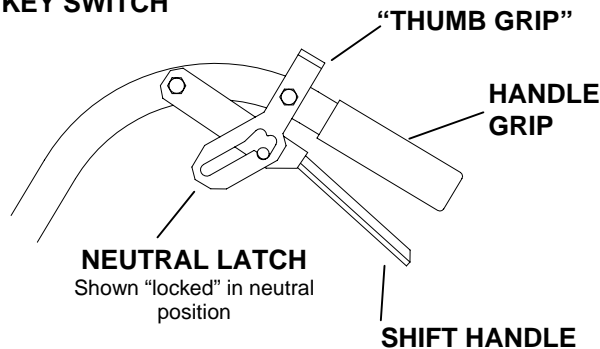

Located towards the right side of the Control Console. When in the "ON" position allows the engine to run. When in the "OFF" position shuts the engine off. Removing the Key can prevent unauthorized operation.

8. THROTTLE/CHOKE CONTROL

Located on the upper right hand corner of the Control Console. Moving Throttle/Choke Control "forward" increases engine speed. Maximum engine speed is obtained when the Throttle/Choke Control stops in the forward "detent" position. Moving Throttle/Choke Control beyond the "detent" position to "full" forward closes the choke on the engine.

9. COLD START RELEASE CHAIN

Located behind the right hand drive tire, on the frame. Pulling the Cold Start Release Chain out away from the frame and then "UP", latching it into the "key-holed" slot on the frame removes belt tension from the Hydrostatic Transmissions, thus easing force required to start engine.

10. DRIVE WHEEL BYPASS VALVES

Located on the top corners of the left hand and right hand Hydrostatic Transmissions. Turning the Drive Wheel Bypass Valves $\frac{1}{2}$ turn counterclockwise will open them, thus allowing the machine to be moved by hand without the engine running. To resume normal operation close these valves. **DO NOT OVER-TIGHTEN.**



WARNING





AVOID INHALING EXHAUST FUMES. CARBON MONOXIDE GAS IS COLORLESS, ODORLESS, CAN CAUSE UNCONSCIOUSNESS, AND IS POTENTIALLY LETHAL. DO NOT RUN ENGINE IN GARAGE OR OTHER CONFINED AREA

OPERATION

1. **TO START:** Open Fuel Shut-off Valve (if previously closed)
2. Move Twin Track Ground Speed Levers into "Neutral".
3. Switch PTO to "OFF" position.
4. Lock Shift Handles into "Neutral" with the Neutral Latches.
5. Turn Key Switch to "RUN"
6. Move Engine Throttle/Choke Control to full choke position for cold starts. For warm starts place Throttle/Choke Control to $\frac{1}{2}$ position.
7. Pull Recoil Rope to start Engine. Adjust Throttle/Choke Control to desired Engine RPM

NOTE: For cold weather starting (or when engine has not been started for a long period of time) pull the Cold Start Release Chain out and up. Hook the Cold Start Release Chain into the "key-holed" slot on the side of the frame. After starting the engine the Cold Start Release Chain must be **SLOWLY** returned to it's original position of operation.

IMPORTANT: Until the operator is familiar with the **Country Clipper** Zero Turning Radius Walk-behind Mower, he/she should follow these recommendations: Disengage the mower blades. Go very slowly until thoroughly familiar with the machine. Keep away from fences, buildings, and other obstructions. Move the Shift Handle(s) and Twin Track Ground Speed Lever(s) smoothly and slowly. Practice until operation is smooth and efficient.

 **CAUTION** 

AVOID HILLS AND SLOPES. USE EXTREME CAUTION WHEN MOWING ACROSS SLOPES. NEVER MOW UP AND DOWN SLOPES.

8. **TO DRIVE:** Hold the Operator Presence Bail down against the handle bar.

Set desired forward ground speed with the Twin Track Ground Speed Levers.

Note: The left hand Twin Track Ground Speed Lever will set the ground speed for the left hand drive wheel and the right hand Twin Track Ground Speed lever will set the ground speed for the right hand drive wheel.

While slowly squeezing both Shift Handles release both Neutral Latches.

Note: Shift Handles should only be squeezed far enough to release Neutral Latches, over squeezing will cause drive wheels to be shifted into reverse.



To travel straight forward slowly release both Shift Handles.

To stop squeeze both Shift Handles back to neutral. Squeezing past neutral will cause machine to travel into reverse.

Squeeze the right hand Shift Handle to turn right. Squeeze the left hand Shift Handle to turn left.

To adjust forward tracking re-adjust the ground speed with the Twin Track Ground Speed Levers. Either slow down the side that is tracking fast or speed up the side that is tracking slow.

To travel in reverse squeeze both Shift Handles past neutral and into reverse.



 **CAUTION** 

FOR SMOOTH, SAFE OPERATION, MOVE THE SHIFT HANDLE(S) AND TWIN TRACK GROUND SPEED CONTROL(S) IN A GENTLE, SLOW MOTION. NEVER MOVE THESE CONTROLS RAPIDLY, ESPECIALLY ON GRADES

To make a zero radius axis turn, gently squeeze either the right hand or left hand Shift Handle past neutral and into reverse, while regulating the opposite Shift Handle at a similar forward speed.

For smooth operation avoid quick, jerky movement of the Shift Handles. Squeeze the Shift handles with deliberate intent and purpose.

9. **BLADE ENGAGEMENT:** Pull up on the PTO Switch to engage blade(s). Pushing down on the PTO Switch will disengage the blade(s).

 **DANGER** 

THE ROTATING BLADE(S) UNDER THE MOWER DECK ARE DANGEROUS. CONTACT WITH BLADE(S) CAN CAUSE SERIOUS INJURY OR DEATH. DO NOT PUT FEET OR HANDS UNDER THE MOWER DECK WHILE THE BLADE(S) ARE ENGAGED.

Note: The engine will stop if the operator releases the Operator Presence Bail while the PTO is engaged.

IMPORTANT: On power units equipped with Kawasaki 15 h.p. engines, NEVER engage blades when engine RPM is less than half throttle. Doing so may cause premature clutch failure and void clutch warranty.

- 10. TO STOP:** Squeeze both Shift Handles into neutral and lock into place with the neutral latches.

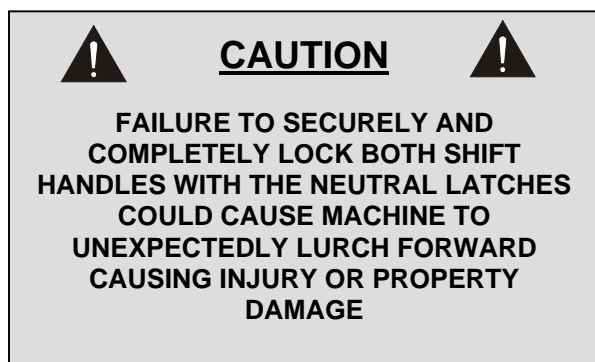

Move the Twin Track Ground Speed Levers into neutral.

Release the Operator's Presence Bail
Turn the Key Switch to "OFF" and remove the Key.

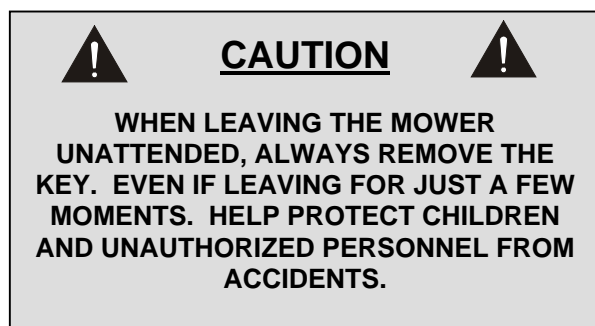

- 11. TO FREE WHEEL MACHINE:** Unscrew bypass valves on both hydrostatic transmissions $\frac{1}{2}$ turn counterclockwise. To reset, turn bypass valves clockwise. **DO NOT OVERTIGHTEN.**

Drive Wheel Bypass Valve

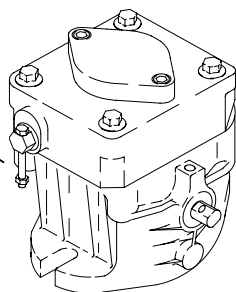

- 12. TO CHANGE DECK CUTTING HEIGHT:**

While lifting the deck, remove the Deck Hanger Hairpin from the Deck Hanger Rod. Re-insert Deck Hanger Hairpin into desired hole on Deck Hanger Rod. **NOTE:** To obtain a level cut, all four Deck Hanger Hairpins must be installed in the same cutting height hole on each of the Deck Hanger Rods.

MOWING RECOMMENDATIONS

1. Keep mower blade(s) sharp.
2. Make sure mower deck and discharge chute are clean.

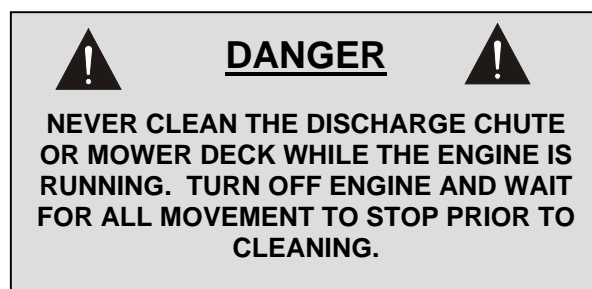

3. When mowing tall grass, make two passes, mowing off $\frac{1}{2}$ of the desired cut height on the first pass, and then the desired cut height on the second pass. Check for hidden dangers first.
4. Go slowly for trimming
5. When cutting grass always run the Engine at FULL throttle. This "Engine" speed allows the mower blades to operate at optimum cutting speed. Control "GROUND" speed with the Shift Handle(s) and/or Twin Track Ground Speed Lever(s).
6. Vary ground speed to suit conditions. (i.e. Go slower in tall thick grass, on slopes, wet conditions, etc.)

SPECIFICATIONS

| POWER UNIT | | |
|--|---------------------------------------|-------------------------------------|
| Model | ZT1400KA | ZT1500KA |
| Engine (see engine Owner's Manual for complete specifications) | 14 h.p. Kawasaki (single cylinder) | 15 h.p. Kawasaki (twin cylinder) |
| Hydrostatic Pumps | Hydrogear BDP-10A | |
| Wheel Motors | Parker-Ross | |
| Turning Radius | Zero-Turn | |
| Ground Speed: Forward | 7 MPH (infinitely variable) | |
| Reverse | 3-1/2 MPH (infinitely variable) | |
| Electric Clutch | Warner Mag-Stop | |
| Length (Power Unit ONLY) | 44" | |
| Height | 43-1/2" | |
| Width (outside rear drive tires) | 35-3/4" | |
| Weight approx. (including deck frame) | 390# | 383# |
| Fuel capacity | 6 Gallons | |
| Belt, Engine to Hydrostatic Transmissions | P/N D-3671 | |
| Hydrostatic Transmission Oil Filter | P/N H-2026 | |
| Tires | | |
| Rear Drive | 16 x 6.50-8 (4 ply) | |
| Front Caster | 9 x 3.50-4 (4 ply) | |

| DECK | | |
|----------------------------------|------------------------------------|------------------------------------|
| Model | 36W | 48W |
| Cutting Width | 36" | 48" |
| Overall Width (w/ chute) | 46" | 58" |
| Overall Length (w/ Power Unit) | 79" | 75" |
| Blades Length | 18-3/8" | 17" |
| Blade Tip Speed | 18,500 – 18,950 fpm | |
| Blade Width x Thickness | 2 1/2" x .204" | |
| Blade Quantity | 2 | 3 |
| Belt, Engine to Deck | P/N D-3684 | P/N D-3606 |
| Cutting Height | 1-1/2" to 4-1/2" (1/2" increments) | 1-1/2" to 4-1/2" (1/2" increments) |
| Weight approx. (less deck frame) | 160# | 185# |
| Material Thickness | 10 ga. | |
| Reinforcement Thickness | 7 ga. | |
| Spindle Bearings | 25 mm | |

NOTE: Power unit should be matched to deck to insure sufficient power is available for intended usage.

NOTE: All specifications subject to change without prior notice

MAINTENANCE



CAUTION



BEFORE PERFORMING ANY MAINTENANCE, TURN OFF ENGINE, REMOVE KEY AND DISCONNECT SPARK PLUG(S). USE EXTREME CARE WHEN WORKING ON MACHINERY. DO NOT WEAR WATCHES OR JEWELRY. DO NOT WEAR LOOSE FITTING CLOTHES, AND OBSERVE ALL COMMON SAFETY PRACTICES WITH TOOLS.

MAINTENANCE SCHEDULE

| SERVICE | WHEN |
|---|---|
| Check Safety Interlocks System ----- | before each use |
| Check for loose hardware ----- | before each use |
| Grease front caster pivots ----- | before each use |
| Check crankcase oil level ----- | before each use |
| Clean grass from Hydrostatic transmission cooling fins----- | before each use |
| Check for loose or damaged hydraulic lines and fittings ----- | before each use |
| Check air intake screen ----- | after each use |
| Clean grass from under deck ----- | after each use |
| Check tire pressure ----- | every 10 hours |
| Sharpen mower blades ----- | every 10 hours |
| Check Hydrostatic Transmission fluid ----- | every 25 hours |
| Check drive belts ----- | every 50 hours (20 hours break-in) |
| Grease deck spindle bearings ----- | every 100 hours |
| Change Hydrostatic transmission oil and oil filter ----- | every 500 hours (100 hours break-in) |
| Clean air filter pre-cleaner element ----- | see engine owner's manual |
| Service/Replace Air Cleaner Filter Element ----- | see engine owner's manual |
| Change engine crankcase oil ----- | see engine owner's manual |
| Change engine oil filter ----- | see engine owner's manual |
| Check/Replace spark plugs ----- | see engine owner's manual |
| Clean engine air cooling system ----- | see engine owner's manual |
| Change/Clean fuel filter ----- | as required |
| ----- | |

Replace decals when illegible. Write factory for free replacement.

MAINTENANCE INSTRUCTIONS

1. ENGINE:

For complete maintenance and operating information for your engine, please refer to your engine operating and maintenance instructions furnished by the engine manufacturer and included in your **Country Clipper** Hydrostatic Drive Walk-behind Mower information packet.

NOTE: Air intake screen must be kept clean. If plugged, engine may be seriously damaged by over heating.

2. TIRES:

Correct tire pressure is essential for efficient operation of the mower. Check tire pressure as requested in the maintenance schedule. Inflate tires to 16 psi.

Lug nuts should be checked regularly for tightness.

3. MOWER BLADES:

Check sharpness of mower blades after every 10 hours of operation. To sharpen blades proceed as follows:

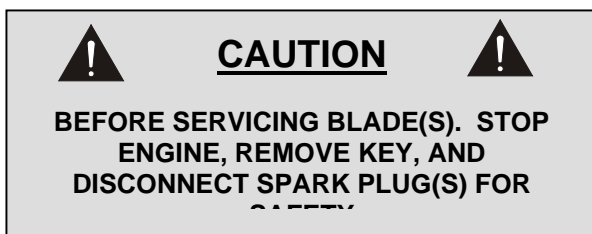

- A. Remove bolt, lockwasher, and cup washer mounting blade on shaft. Remove blade.

NOTE: Servicing the underside of the deck can be simplified by raising the deck into the servicing position. See Page 16 on how to raise deck into servicing position.

- B. Blades should be discarded when worn excessively.
- C. Sharpen blades with a hand file, electric grinder or blade sharpener. Wear gloves and eye protection when sharpening. Grind blade at original 25 degree bevel.

- D. Check balance of blade by positioning the blade on a nail or blade balance pedestal. Grind the blade on the end that is heavier until both sides balance.
- E. Install blade, cup washer, lockwasher, and bolt. Make sure to tighten bolt to 60 ft.lbs.

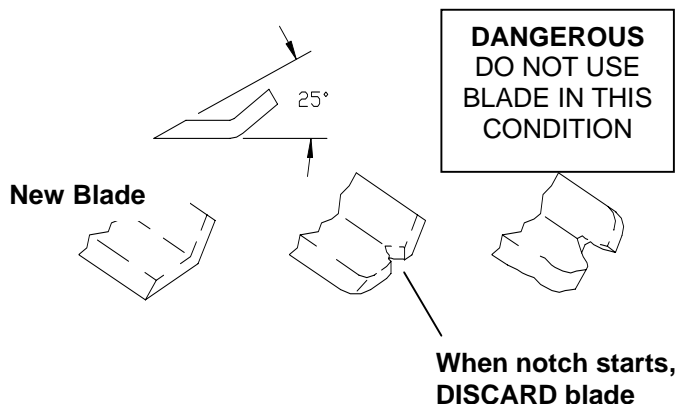

4. V-BELTS:

All belts should be checked every 50 hours. Replace any belts found to be in poor condition. All belts are equipped with spring loaded belt tighteners and do not require tightening adjustments.

NOTE: See page 19 for belt routings.

5. LUBRICATION:

- A. **Engine:** Follow engine manufacturer's recommendations.
- B. **Deck Spindles:** Lubricate with 3 "shots" only, every 100 hours.
- C. **Hydrostatic Transmission and filter:**

Check the oil level in hydrostatic transmission oil reservoir after every 25 hours of usage. The proper oil level should register within the sight window of the oil reservoir cover.

When adding oil be very careful to keep the reservoir clean. Clean the Oil Reservoir Cap and the surrounding area prior to removing the Oil Reservoir Cap.

Replenish oil supply as required with 20W-50 Motor Oil. **DO NOT OVERFILL.**
(continued next page)

Change the oil in the reservoir and Hydrostatic Transmission Filter after the first 100 hours of operation, and then every 500 hours after that. Remove the filter and be sure that all oil has drained from the reservoir. Replace with new filter (P/N H-2026) and 20W-50 Motor Oil.

! WARNING !

PORTIONS OF HYDRAULIC SYSTEM CAN OPERATE UNDER HIGH PRESSURE. HYDRAULIC FLUID ESCAPING UNDER PRESSURE MAY HAVE SUFFICIENT FORCE TO PENETRATE SKIN AND CAUSE SERIOUS INJURY. HYDRAULIC FLUID INJECTED INTO THE SKIN MUST BE SURGICALLY REMOVED WITHIN A FEW HOURS BY A DOCTOR FAMILIAR WITH THIS FORM OF INJURY OR GANGRENE MAY RESULT. (see Hydraulic Schematic on page 20)

amounts. If rear drive tire “creeps” into reverse shorten the reverse link rod assembly. Re-tighten lower jam nut when length adjustments are completed. Verify collapsed length of reverse spring. Repeat for other side.

D. NEUTRAL AT THE TWIN TRACK GROUND SPEED LEVERS

- i) Move the Twin Track Ground Speed Levers into neutral position. If rear drive tire is “creeping” forward shorten the forward link rod assembly by loosening and repositioning the jam nuts . Lengthen the forward link rod assembly if the rear drive tire “creeps” into reverse. Repeat for other side.

NOTE: If this adjustment cannot be maintained, verify that spring located on the pivot point of the Twin Track Ground Speed Levers is collapsed to approximately 11/16”.

6. NEUTRAL ADJUSTMENTS:

- A. Raise rear drive tires high enough to clear the ground and securely support.
- B. Start engine and run at full throttle.
- C. **NEUTRAL AT THE SHIFT HANDLES**

- i) Shift the Twin Track Ground Speed Levers approximately into the middle speed position.

NOTE: Operator Presence Bail must be held down when shifting the Twin Track Ground Speed Levers out of neutral.

- ii) Verify that the reverse spring is collapsed to approximately 1-1/16”. Adjust collapsed length of reverse spring using the spring collapse jam nut. Repeat for other side

NOTE: This can be done prior to starting the engine.

- iii) Squeeze the Shift Handles until increased pressure is felt.. If the rear drive tire is moving adjustment is required. Loosen the lower jam nut from the reverse link rod assembly. If the rear drive tire is “creeping” forward lengthen the reverse link rod assembly by moving the top jam nut and the spring collapse jam nut equal

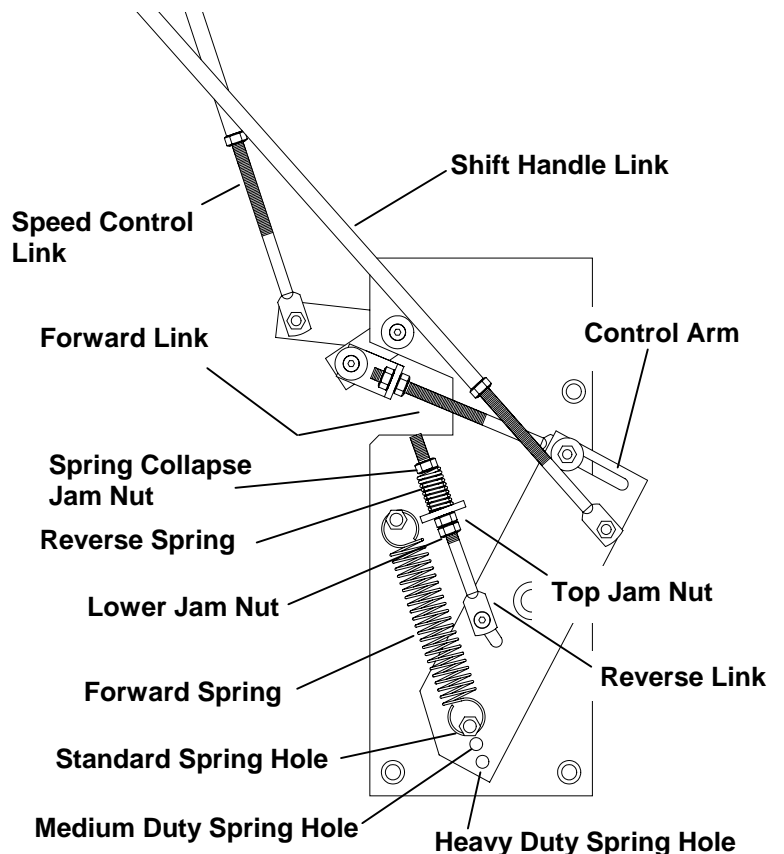

E. NEUTRAL AT NEUTRAL LATCHES

- i) Shift the Twin Track Ground Speed Levers into the middle speed position.
- ii) Squeeze the Shift Handle into neutral (as previously adjusted). Rotate the "Thumb Grip" portion of the neutral latch rearward and release the Shift Handle, locking the Shift Handle into the neutral position. If the rear drive tire "creeps" forward shorten the Shift Handle Link Rod Assembly. If the rear drive tires "creeps" into reverse lengthen the Shift Handle Link Rod Assembly.

NOTE: The Shift Handle Link Rod must be disconnected from the Shift Handle in order to change the length.

7. FORWARD TRACKING ADJUSTMENT:

- A. If forward travel of the machine veers left or right on level ground when the Twin Track Ground Speed Levers are set at the same forward position lengthen or shorten Speed Control Link Rod. Lengthening the Speed Control Link Rod will increase forward ground speed and shortening the Speed Control Link Rod will decrease forward ground speed.

NOTE: It may be necessary to re-adjust neutral following this adjustment.

8. HYDROSTATIC TRANSMISSION CONTROL ARM TENSION SETTINGS:

- A. For heavy or medium duty drive conditions (i.e. when pulling a sulky unit, or carrying a grass collection system), added spring force might be required on the Control Arm of the Hydrostatic Transmissions to prevent the hydraulic drive system from slowing down while pulling the extra load.
- B. To increase spring force, remove the Forward Spring from the mounting bolt. Remove the mounting bolt on the Control Arm and place it into one of the lower holes. Re-connect the Forward Spring to the Control Arm.

NOTE: The middle hole on the Control Arm is for "medium duty" service and the bottom hole on the Control Arm is for "heavy duty" service.

9. LEVELING THE MOWER DECK:

- A. Move machine onto hard level surface (i.e. concrete or blacktop).
- B. Set tire pressure on all four tires.
- C. Place all four Deck Hanger Hairpins so that deck is in highest cutting height.
- D. With all blades tips rotated to point straight forward measure from the ground to the front blade tips. If blade tips measure more than 3/16" different loosen the jam nuts on the Deck Hanger Rods. Adjust length of the appropriate Deck Hanger Rods until blade tips are within 3/16" of each other. The rear blade tips should be approximately 1/8" farther from the ground than the front blade tips. The deck should hang firmly on all four Deck Hanger Rods. Tighten the jam nuts on all four Deck Hanger Rods once desired side-to-side level and front-to-back rake is obtained.

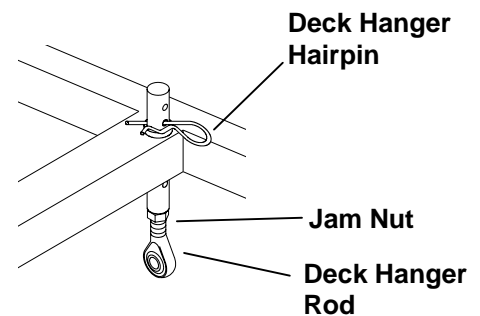

10. RAISING THE DECK TO SERVICE POSITION:

- A. Change deck cutting height to be at the mid-position OR lower.
- B. Position the front caster wheel to point away from the deck (such as the mower would be travelling in reverse).
- C. Remove Belt Cover and push back the Ball on the idler bar releasing tension on belt. Remove the engine to deck belt from spindles.
- D. Remove Rear Deck Hanger Hairpin. Remove Lynch pin from Rear Deck Hanger Clevis pin. Remove Rear Deck

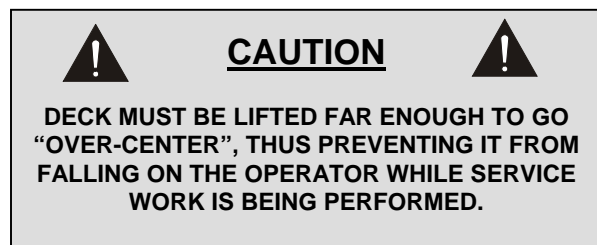

Hanger Clevis pin. Re-Install rear Deck Hanger Hairpin. Repeat for other side.

- E. Push down on handle bars until deck fully rotates up to the service position.

11. LOWERING THE DECK TO OPERATION POSITION:

- A. Push down on Handle bars raising the deck off of the ground. Push the machine forward while lowering the deck back to the ground.
- B. Remove Rear Deck Hanger Hairpins. Re-install Rear Deck Hanger Clevis pins and Lynch pins. Re-Install Rear Deck Hanger Hairpin.
- C. Re-install the Engine to Deck Belt back onto the Spindle pulleys (see page 19 for proper belt routing).
- D. Re-install the Belt Cover.
- E. Re-position Deck Hanger Hairpins on the Deck Hanger Rods to desired cutting height.

Deck Shown Raised into the SERVICE Position

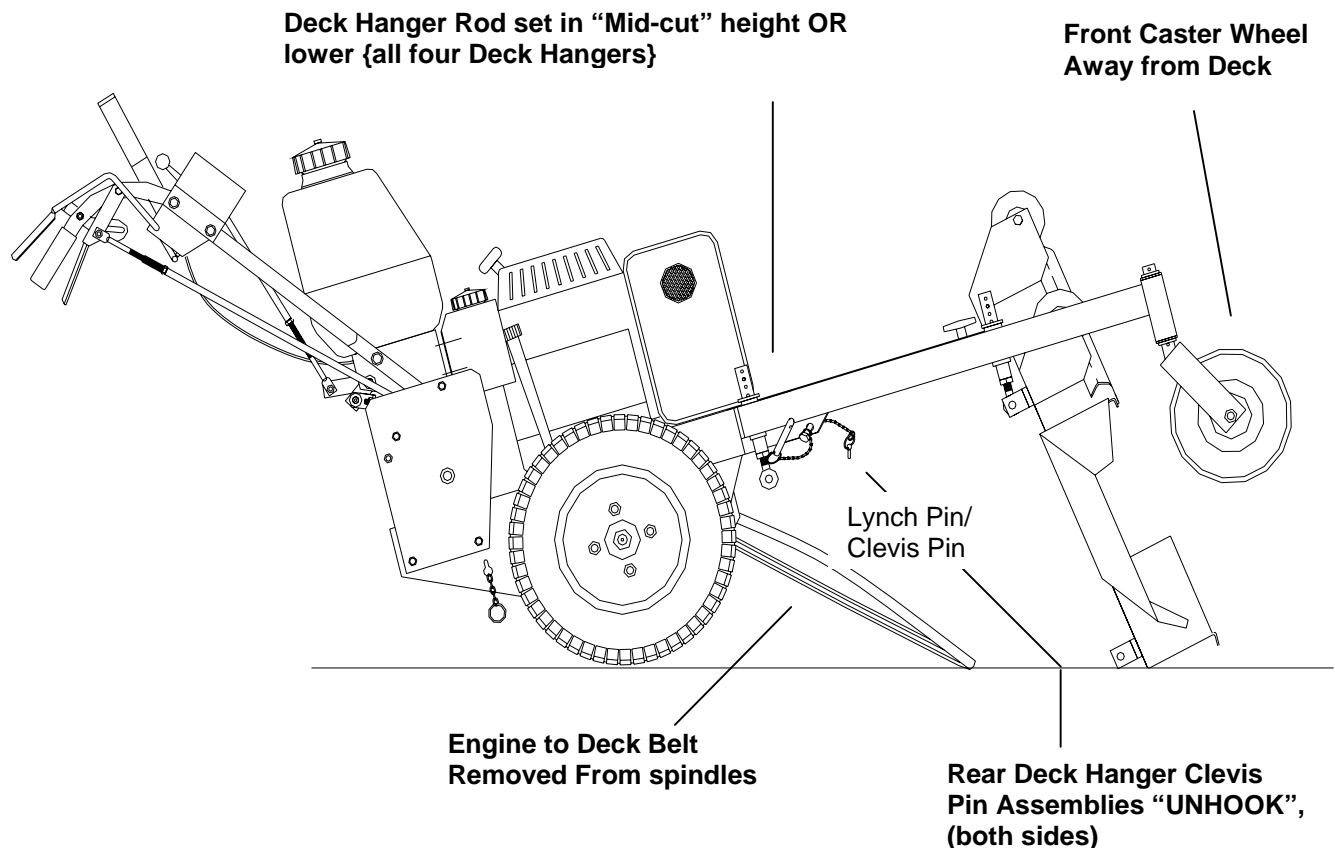

TROUBLE SHOOTING CHECKLIST

1. ENGINE WON'T START:

- Key Switch is "OFF" ----- turn key switch "ON"
- Mower blades engaged ----- disengage PTO
- Drive not in neutral ----- move Twin Track Ground Speed Levers into "Neutral" position
- Fuel shut-off Valve Closed ----- open fuel shut-off valve
- No gas ----- refuel
clean or replace fuel filters
- Over or under choked ----- adjust choke
- Spark plug not firing ----- check spark plug
condition and reset gap*
- Carburetor maladjustment ----- reset carburetor adjustment*
- Ignition switch ----- consult dealer

2. HARD TO START ENGINE:

- Fuel line clogged ----- clean fuel line and check fuel filter
- Spark plug wire loose or grounded ----- check spark plug wires
- Spark plug(s) faulty or improperly gapped ----- check spark plug
condition and reset gap*
- Electronic ignition defective ----- consult dealer
- Dirty or maladjusted carburetor ----- readjust carburetor*
consult dealer for carburetor service

3. ENGINE STARTS BUT CUTS OUT:

- Water in gasoline ----- drain old gasoline and replace with new gasoline
clean carburetor bowl
- Clogged fuel line ----- check fuel filter
clean fuel line
- Vent in fuel cap plugged ----- check vent
- Maladjusted carburetor ----- readjust carburetor*

4. ENGINE KNOCKS:

- Low oil level ----- check and add oil
- fuel octane too low ----- drain and replace with
higher octane gasoline
- Over heated engine ----- shut off engine and allow to cool

5. ENGINE SOMETIMES SKIPS AT HIGHER SPEEDS:

- Carburetor maladjusted ----- readjust carburetor
- Faulty spark plugs ----- check spark plug
condition and reset gap*
- Operator's Presence Bail is being released ----- slow down on rough terrain

6. ENGINE OVER HEATED:

Air intake screen or fins clogged ----- clean intake screen and fins
 Fuel mixture too lean ----- readjust carburetor*
 Oil level too low or too high ----- adjust oil level
 Running engine too slow ----- run engine faster

(NOTE: Always mow at full throttle setting.)

7. ENGINE IDLES POORLY:

Carburetor maladjustment ----- readjust carburetor
 Improper spark plug gap ----- check and re-gap plug*

8. ENGINE BACKFIRES:

Carburetor maladjustment ----- readjust carburetor*

9. ENGINE RUNS BUT MOWER WON'T MOVE FORWARD:

Drive belt broken or slipping ----- replace drive belt
 Hydrostatic Transmission shift arm disconnected ----- reconnect
 Hydrostatic Transmission oil low ----- add oil
 Transmission in free wheel position ----- tighten bypass valves (see pg. 10)
 Hydrostatic Transmission oil filter plugged ----- replace filter
 Loose Hydrostatic Transmission Oil----- Tighten or replace Transmission oil filter
 Bad Hydrostatic Transmission or Wheel Motor ----- consult dealer

10. MOWER LOSES POWER OR TRANSMISSIONS OVER HEATS:

Hydrostatic transmission oil too low or too high ----- add oil
 OR drain oil as needed
 Hydrostatic Transmission damage ----- consult dealer
 Hydrostatic Transmission blowing oil out cap ----- overfilled or water
 contaminated

11. ENGINE STALLS WHEN BLADES ARE ENGAGED:

Operator Presence Bail Released -----Hold Operator Presence Bail down
 Faulty interlock system ----- consult dealer
 Bad blade spindle bearing ----- consult dealer
 Deck drive belt not properly routed ----- reroute
 Blades blocked by foreign material ----- clean under deck

12. DECK CUT UNLEVEL:

Low air pressure in tire ----- adjust tire pressure
 Deck Mounting Hair Pins not in same holes ----- move Hairpins into same holes
 Deck Hanging Pins out of adjustment ----- adjust hanging pins
 Bent Blade(s) ----- replace blade(s)

- See engine manual for engine adjustments.

BELT ROUTINGS

48" ENGINE TO DECK BELT

Belt P/N D-3606

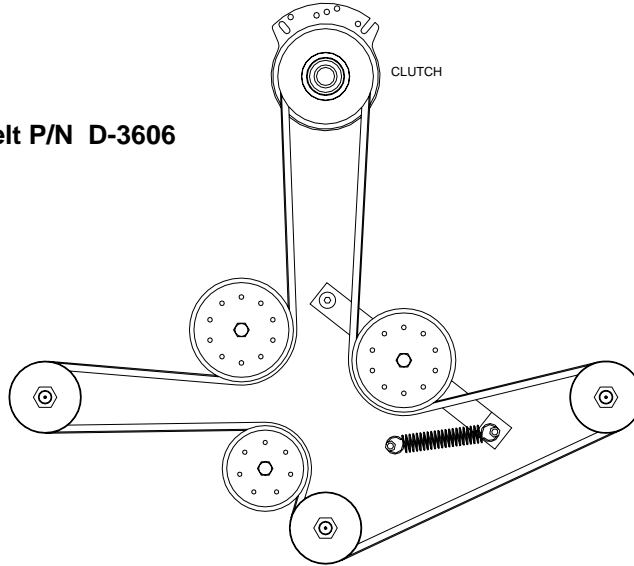

36" ENGINE TO DECK BELT

Belt P/N D-3684

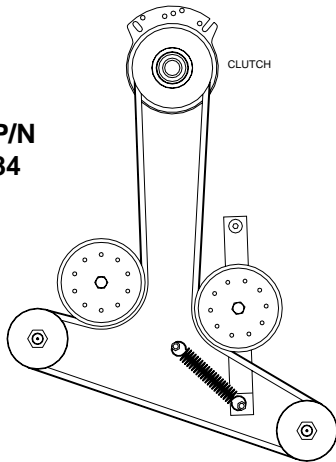

HYDROSTATIC TRANSMISSION

LEFT HAND
HYDROSTATIC
TRANSMISSION

RIGHT HAND
HYDROSTATIC
TRANSMISSION

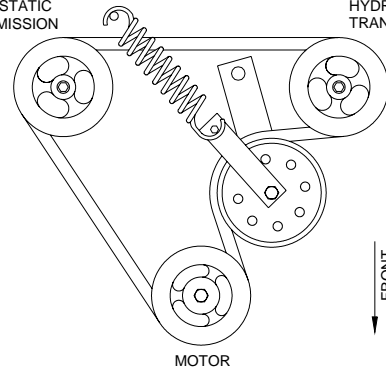

Belt P/N D-3671

FRONT
↓

VIEWED FROM GROUND LOOKING UP

WIRING SCHEMATICS

14 HP KAWASAKI (ZT1400KA)

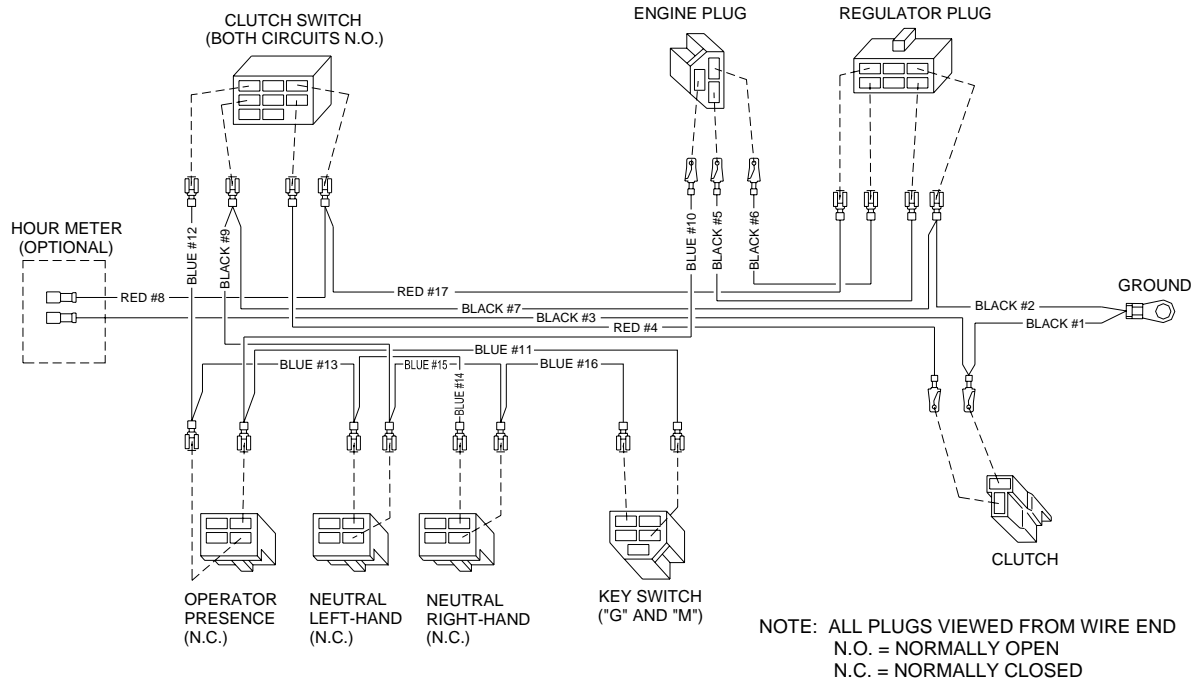

15 HP KAWASAKI (ZT1500KA)

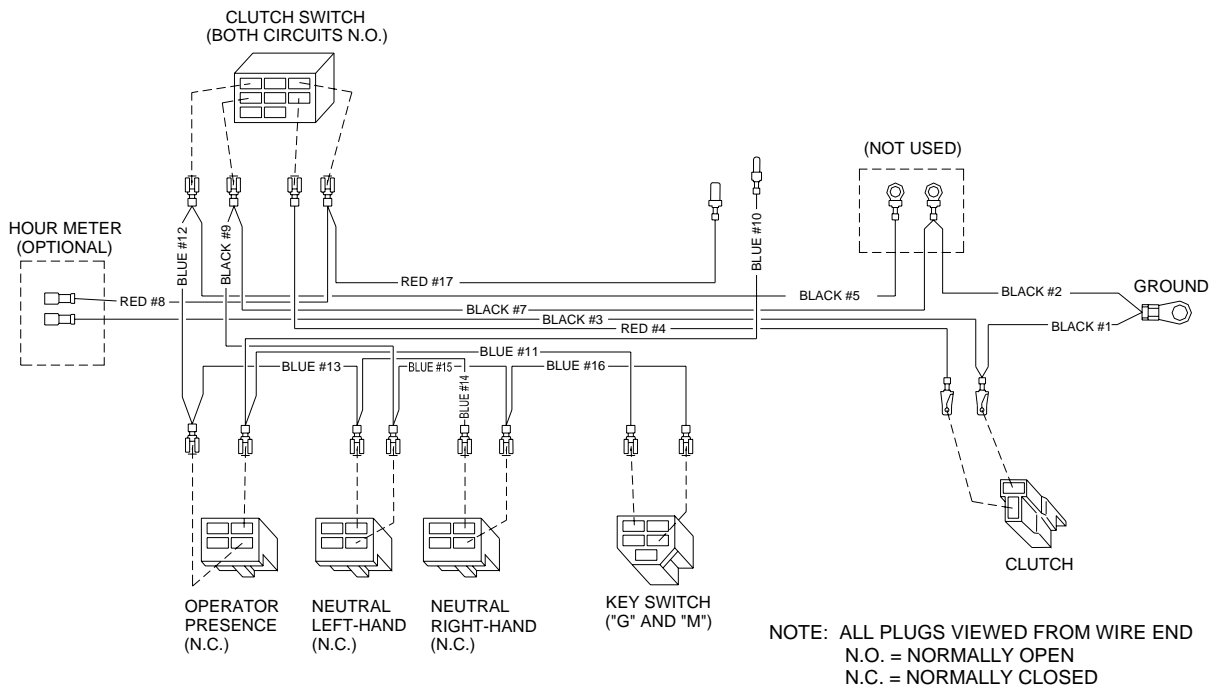

HYDRAULIC SCHEMATIC

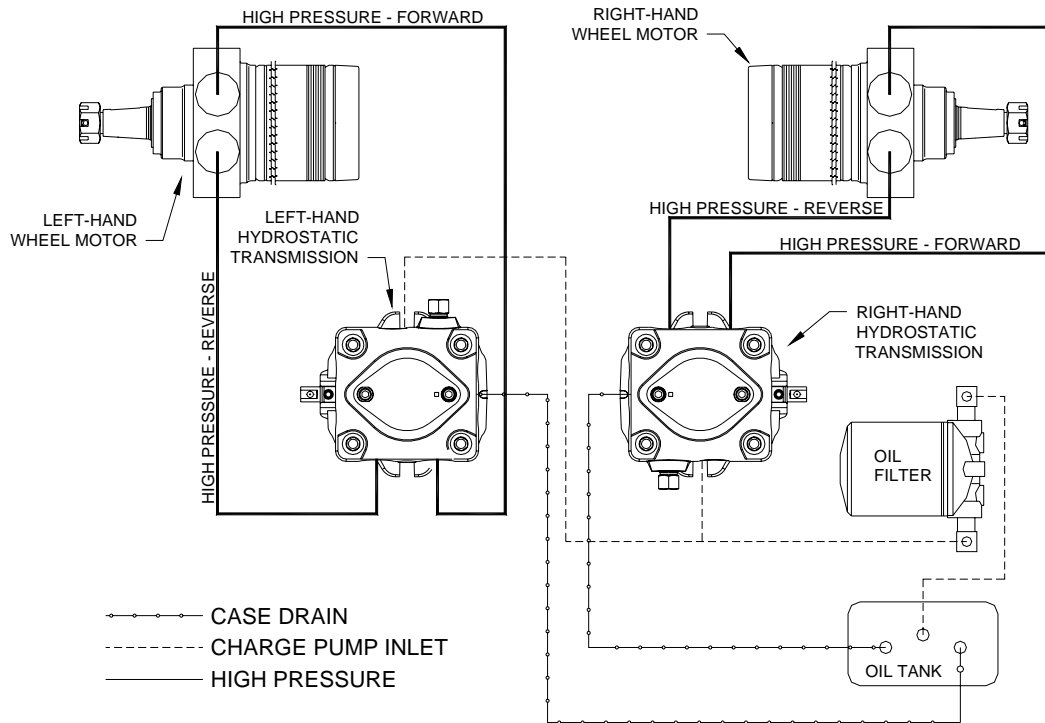

NOTES / SERVICE RECORDS

| DATE | SERVICE WORK COMPLETED |
|------|------------------------|
| | |
| | |
| | |
| | |
| | |
| | |
| | |
| | |
| | |
| | |
| | |
| | |
| | |
| | |
| | |
| | |
| | |
| | |
| | |
| | |